

T-Mull with Sill Flashing CE-13716 Installation Guide

IG-063 REV. 08/23 V1.1

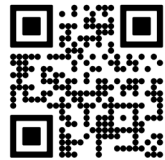

T-Mull

Scan Here for a Digital Version of the
Installation Guides in English.

Quartz Luxury Windows & Doors:
www.quartzluxurywindows.com



T-Mull

Scan Here for a Digital Version of the
Installation Guides in English.

Quartz Residential Windows & Doors:
www.quakerresidentialwindows.com

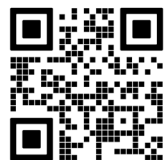

T-Mull

Scan Here for a Digital Version of the
Installation Guides in English.

Quaker Commercial Windows & Doors:
www.quakercommercialwindows.com



Para ver las instrucciones en Espanol, escanea aqui.

If this set of instructions does not match your installation method or the wall conditions of the job site, please check our website listed below for other options, or call Quaker Customer Service for additional information.



Quaker Window Products
504 U.S. Hwy 63 South
Freeburg, MO 65035
(800) 347-0438
www.quakerwindows.com



PO Box 128 | 504 Highway 63 South | Freeburg, MO 65035 | 800-347-0438 | 573-469-4151 (fax)

Application Guidelines for T-mull with Sill Flashing CE-13716.

(Follow Installation **IG-021_Aluminum_Snap trim_installation guide** for perimeter installation)

Read these instructions completely before starting any installation. Failure to install and maintain our product according to these instructions may void any product warranty. Please visit our website at www.quakerwindows.com or call 1-800-347-0438 for additional information.

Tools required by installer:

Safety Glasses		Utility Knife	
Drill/Driver		Caulk Gun	
Level		Tape Measure	
Hammer		Pliers	

Materials required by installer:

Foam Backer Rod		Minimally Expanding Foam	
Shims (Waterproof)		Sealant	
Fasteners		IPA Alcohol	

 **WARNING**

Tools

- Follow manufacturer’s instructions for safe operation of tools, and ladders/scaffolding. Always wear safety glasses. Failure to do so could result in injury, product or property damage.

Handling

- Do not store units outside, or in a hot environment. Doing so could result in product damage.
- Do not carry flat.** Doing so could result in product damage, injury, or property damage.
- Stack units as straight as possible to avoid bowing. **Do not lay flat!**

Glass

- If broken, glass can fragment causing injury. All Quaker products are available with safety glass. In many areas, local building codes require safety glass in certain locations and/or applications. Unless safety glass is ordered, Quaker windows are not provided with safety glass. Before ordering, consult your local building codes for more definitive information.

Fastening

- Metal fasteners and components could corrode when used with preservative-treated lumber. Use approved fasteners and components to fasten window or door. Failure to do so could cause a failure resulting in injury, product or property damage.
- Fastener must attach to a structural framing member with 1 1/2” minimum fastener embedment, or minimum 3 full threads with a minimum 5/16” head as products were tested with.
- Quaker does not supply anchorage/fastener calculations, and is not responsible for determining structural adequacy of the anchorage and fasteners used to install our products, or the openings into which they are installed.**
- Do not over drive screws or nails.** Doing so could result in product damage.

CAUTION**Installation**

- Always support window or door in opening until fully fastened. Failure to do so could result in the window or door falling out or causing injury, product, or property damage.
- Nailing flanges and drip caps (integral or applied) **do not** take the place of window flashing. All windows and doors must be properly flashed and sealed with material compatible sealant for protection against water and air infiltration around the entire perimeter. Failure to do so could result in product or property damage.
- **Do not** set window directly on sill plate. Place shims under the side jambs. Window or door must be properly shimmed. Failure to do so could affect operation and product performance and could result in product damage.
- Live or dead loads transferred into our product can affect functionality, damage frame joinery or cause glass failures. Dead loads such as upper levels, roof, etc. Should be constructed before window or door is installed.
- Loads shall be designed to withstand the most critical effects of load factors and load combinations as required by the building code. (Loads are including but not limited to Live, Dead, Collateral, Auxiliary, Thermally induced, Seismic, etc.)
- Maximum vertical deflection of the header under all Load combination should not exceed the Span/720 or 1/4" whichever is less.
- Windows and doors have small parts. Small parts if swallowed could pose a choking hazard to young children. Dispose of unused, loose, or easily removed small parts. Failure to do so could result in injury.
- **Do not** drill through or into window sill to install alarm wires.

Sealing

- Follow instructions of foam, sealant, and flashing manufacturers regarding safety, material application, compatibility, and periodic maintenance for continued weather resistance of their products. Failure to do so could result in product or property damage. **DO NOT** overfill between the frame and opening.
- Minimally expanding foam insulation must be compliant with AAMA 812-19.
- Quaker recommends 100% silicone (ASTM C920 compliant) neutral cure only sealant. Always clean all areas where sealant will be applied. Failure to do so could result in product or property damage.
- Flashing tape must meet ASTM-D779 performance requirements.
- Maintain a minimum of 1/4" between the window or door frame and exterior finish materials. Failure to do so could result in product or property damage.

Joining

- Do not join any window or door to any window or door not designed for joining. Joined windows and doors must be individually supported in the opening. Failure to do so could affect operation and product performance and could result in product or property damage.

Cleaning

- Acid solutions used for cleaning will damage glass, fasteners, hardware, and metal flashing. Protect these products and follow cleaning products manufacturers instructions. If acid contacts the window or door, wash all surfaces immediately with clean water.
- **Do not** use razor blades to clean glass surface. Glass damage could result.
- Clean glass using liquid glass cleaner.
- Clean frame, sash, panels, and insect screens using mild detergent and warm water with a soft cloth or brush.

IMPORTANT

- Buildings constructed prior to 1978 could contain lead paint which could be disturbed during window or door replacement. For more information on proper management of lead paint, go to: www.epa.gov/lead
- Care must be taken to properly recycle or dispose of old materials. Any recyclable materials should be separated from non-recyclable or hazardous materials. Please consult with local or state authorities regarding proper disposal of non-recyclable or hazardous materials.
- These are generic instructions intended to cover most common situations, which may not be appropriate for all installations due to building design, construction materials, or methods used and/or building or site conditions. Consult a contractor or architect for recommendations.
- Inspect all units for any damage or defects prior to installation. Contact the nearest Quaker distributor if there are any problems.

1

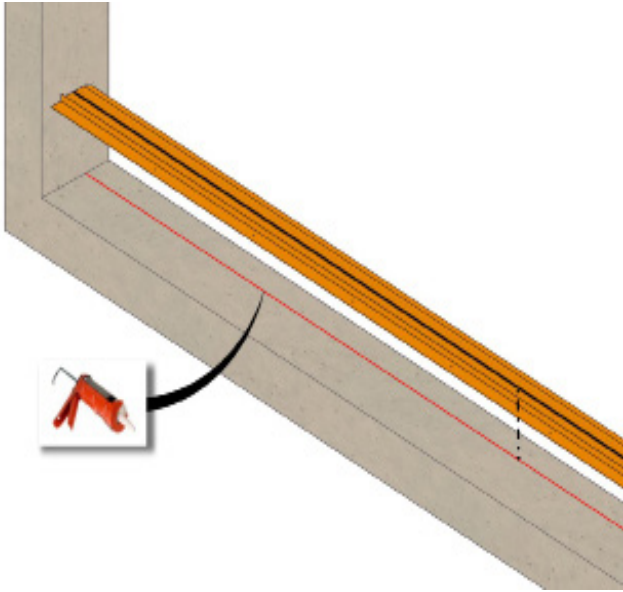

Apply Continuous bead of sealant which the sill flashing will set on.

2

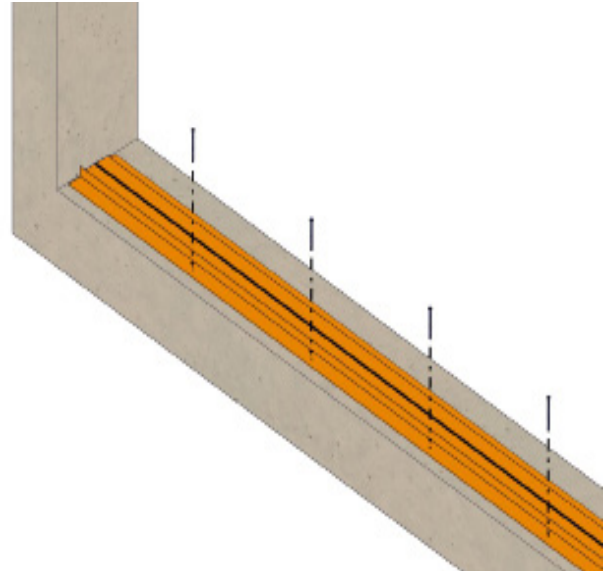

Set sill flashing on the continuous bed of sealant. Install through the interior anchor leg using fasteners supplied by the insaller.

3

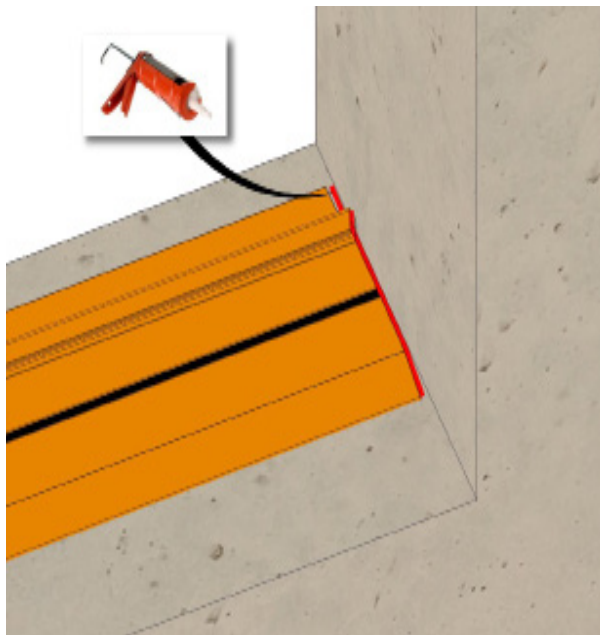

Apply sealant to both ends of the sill flashing to the center post and wall framing to create an end dam.

4

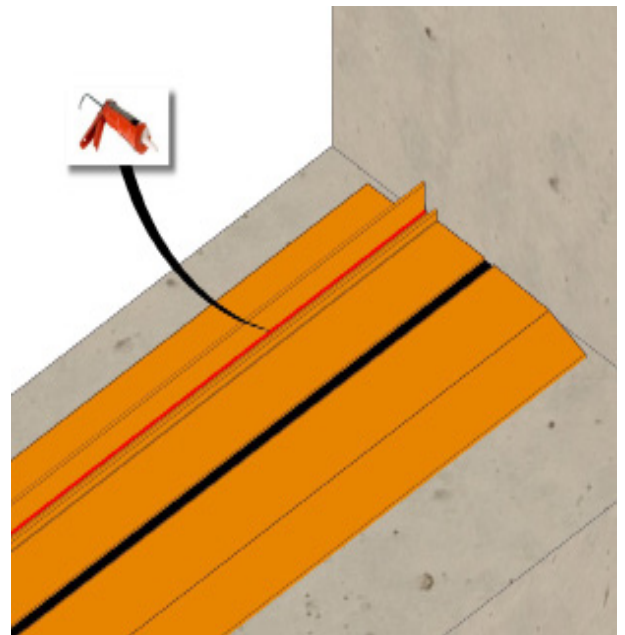

Apply a continuous bead of sealant into the track where the inside window leg will rest.

5

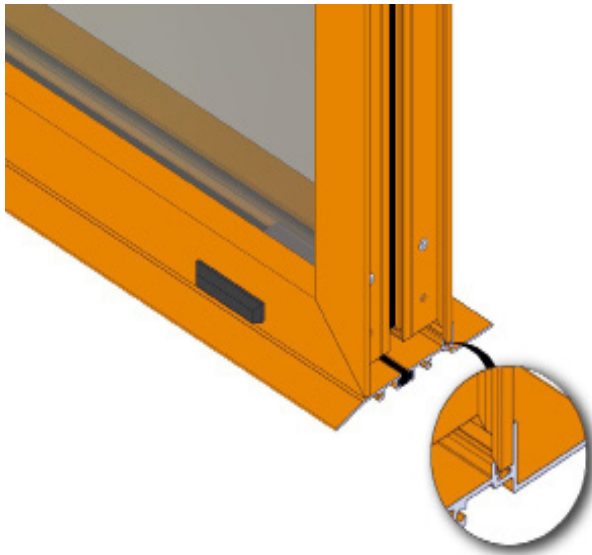

Install the first window in the continuous bead of sealant and use the snap trim clips provided.

- Follow the standard snap trim guidelines.

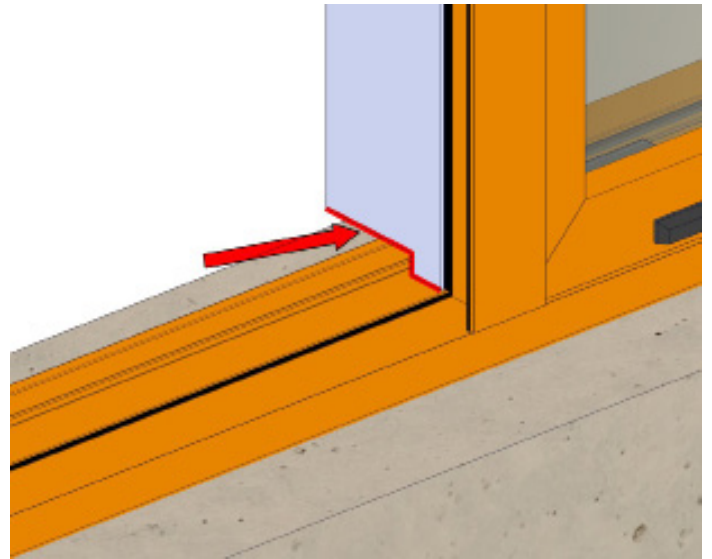

Cut T-Mull to match window height and notch at the sill ($1/2 \times 2 3/4$) to clear the interior leg of the sill flashing.

6

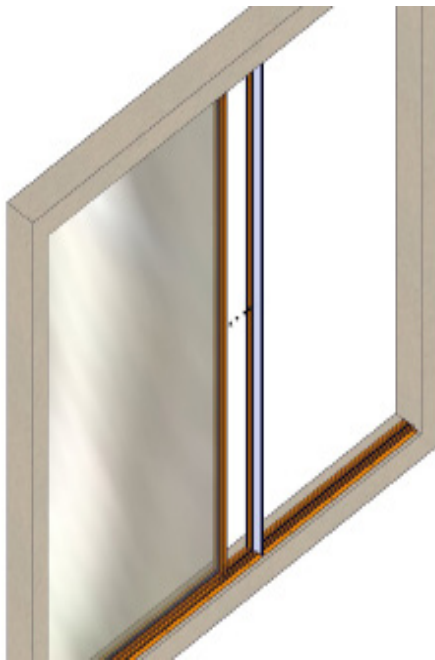

Install the T-Mull. Measure to locate the spacing between the T-Mull and the window matches the shop drawings.

7

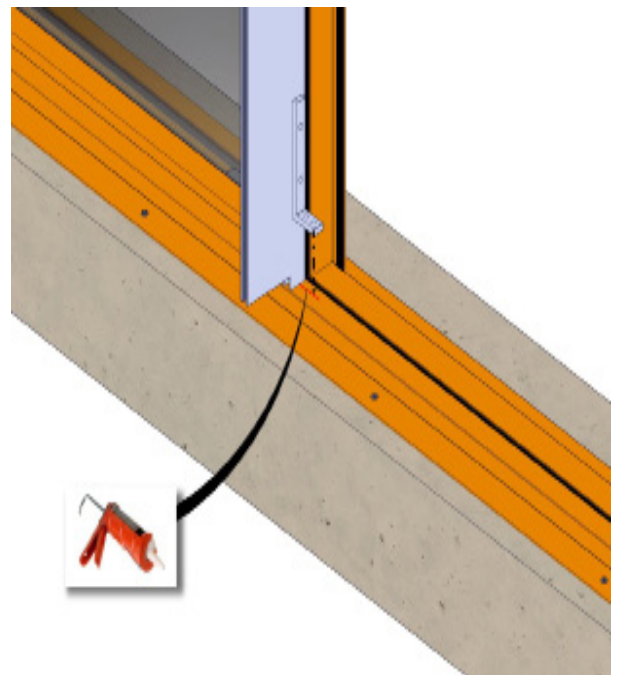

Install L-Angles in a bed of sealant.

7

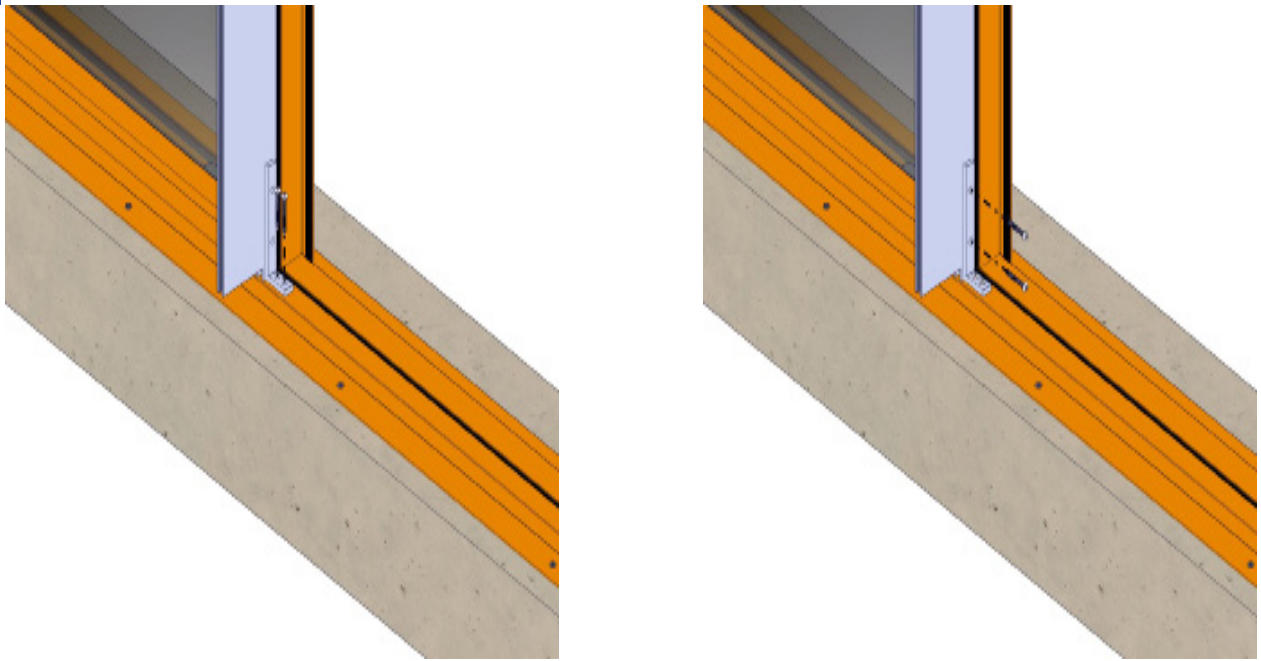

Fasteners provided by QWP are to be used to fasten the angle to the T-Mullion. Fastenes to install into the opening to be supplied by installer.

8

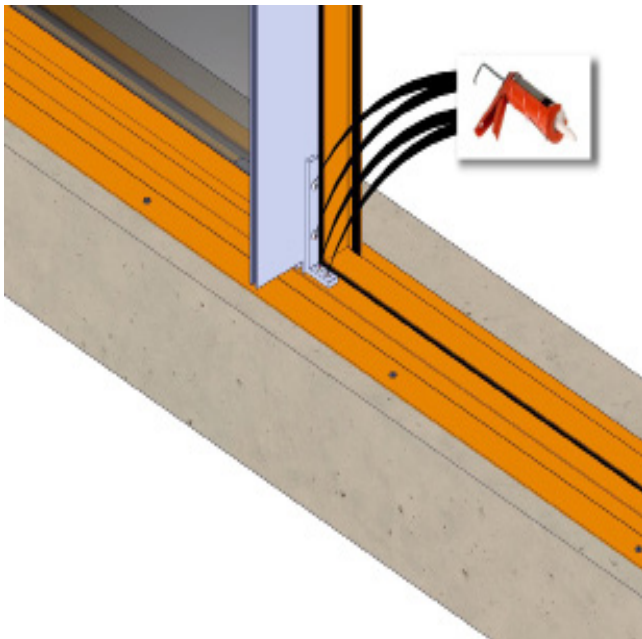

Seal fastener heads after they are installed.

- Install next window following Step 5.

9

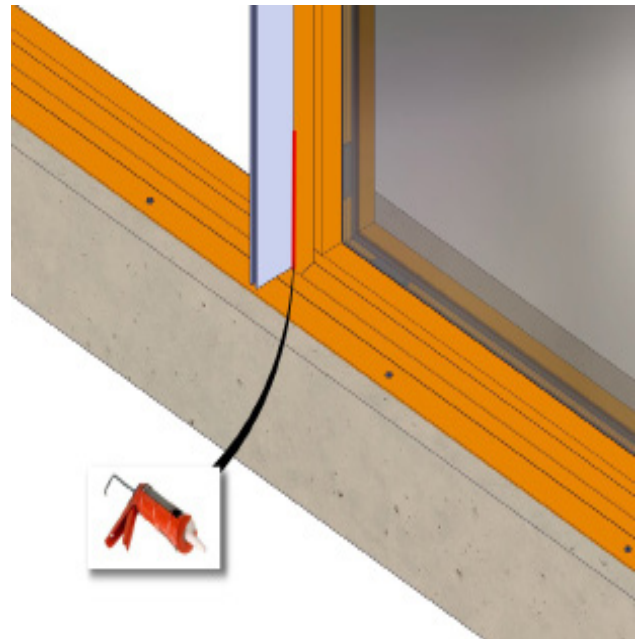

Seal the Windows to the T-Mullion and up 6" from the sill

10

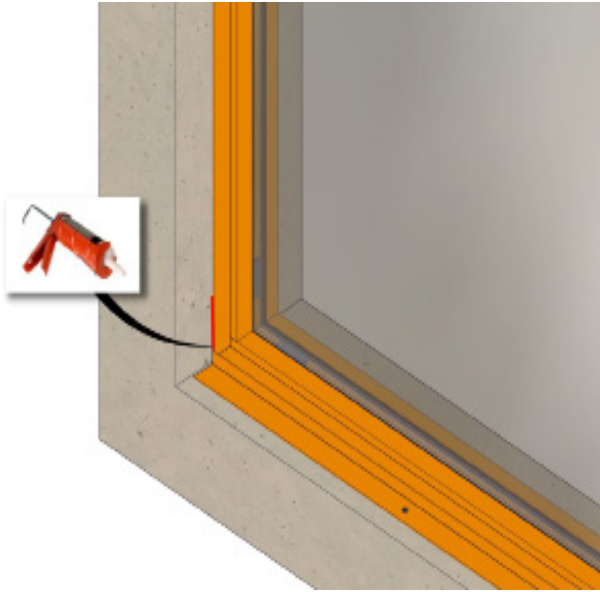

Seal the windows to the opening up 6" from the sill.

11



Install the T-Mull base plate using bolts provided by QWP.

- Cut length will be Window Height - 1/2"

12



Install T-Mull base plate cover to finish mullion.



Application Guidelines

T-mull with Sill

Flashing CE-13716

If this set of instructions doesn't match your installation method or wall conditions please check our website listed below for other options, or call the office.

Scan here for a digital version of these guidelines in English



Scan here for a digital version of these guidelines in Spanish



Or go to: <https://www.quakercommercialwindows.com/resources/installation-instructions-english/>

Or go to: <https://www.quakercommercialwindows.com/installation-instructions-spanish/>

